



viable is a new design studio founded
by **magnus long, charles
trevelyan** and **gala wright**.
dedicated to producing work that is
striking, intelligent and manufacturable,
they have been featured in numerous
publications since their launch in
september 2005.

as well as producing their own
products, **viable** design for a
range of manufacturers and
take on commissions.

43-44 Durant Street
London **E2 7BP**

+44 (0)7753835322

mail@viablelondon.com

magnus long designs objects using simple, elegant forms. he often combines hard materials and refined shapes to produce rational designs for manufacture.

charles trevelyan has a strongly graphical element to his designs. angular and geometric, his furniture designs feature an ingenious use of positive and negative space, while his lighting products focus more on visual character.

gala wright often uses tension over compression in her work. her quietly elegant products convey a sense of lightness without sacrificing strength.

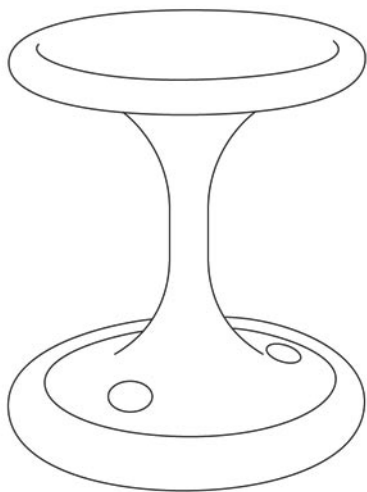

Viable
www.viablelondon.com

core
charles trevelyan 2006

table lamp in spun aluminium with lacquered base and cap.

a table lamp that relies on reflection from the central anodised aluminium core to disperse the light, **core** differs from most table lamps that use a conventional shade. whether on or off, the curved form of **core** has a strong visual identity.

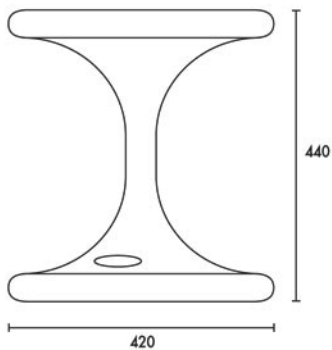

core

lacquered MDF and spun aluminium

available in gloss white, signal red and black

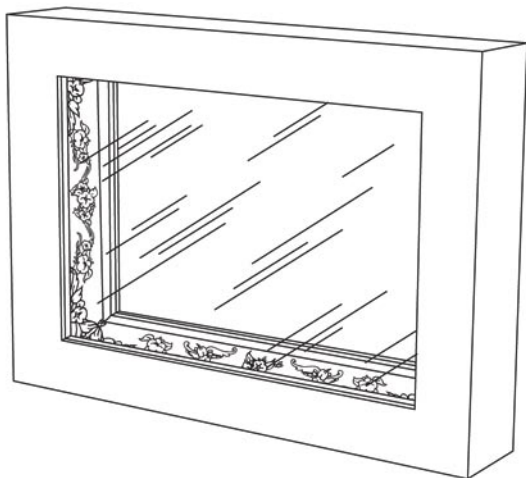

Viable
www.viablelondon.com

cortes
charles trevelyan 2006

inverted frame mirror with internal lighting

cortes takes the trend for highly decorative, classically inspired objects and turns it inside out. the result is a seemingly plain mirror frame that only reveals the ornate gilt frame as you move in close to it. lighting inside the frame gives off a gentle glow and illuminates the user.

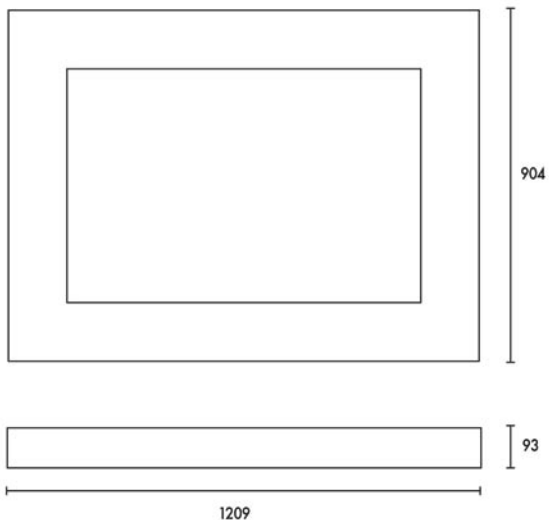

cortes

lacquered MDF, gilt plaster and timber frame, mirror and lighting
available in gloss white and black

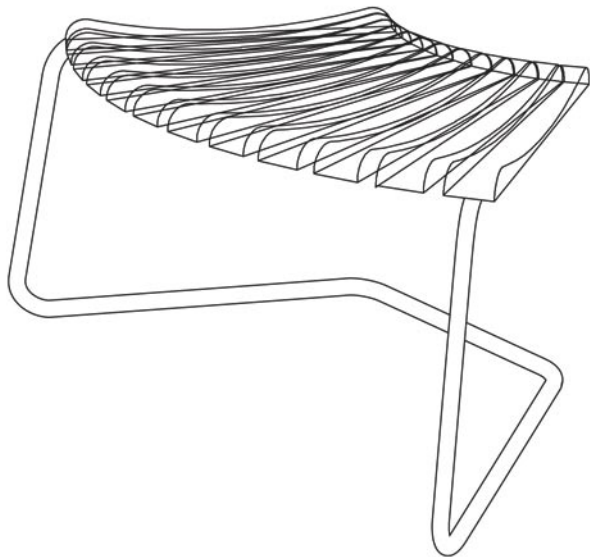

Viabile
www.viablelondon.com

delta
gala wright 2006

modular seating system, with a cantilevered under-frame.

a highly flexible system, the form of the gently curved slats make it especially comfortable for casual seating suitable for use in the garden, indoors or even as public seating. it has a fluid, tubular frame and an inviting but minimal profile.

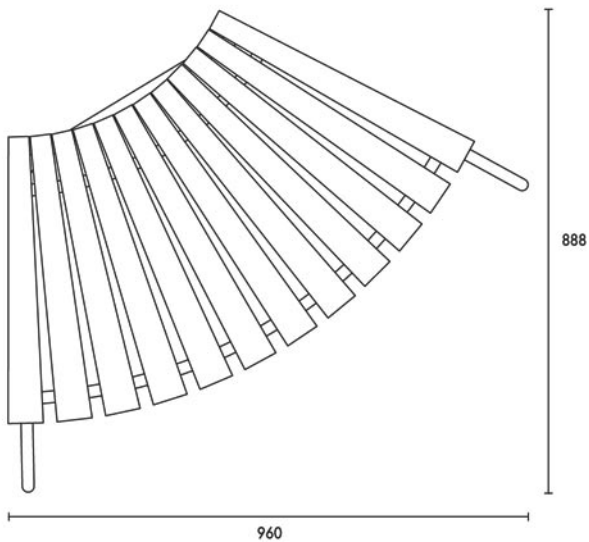

delta

tubular steel frame with lacquered birch ply seat

available in gloss black only

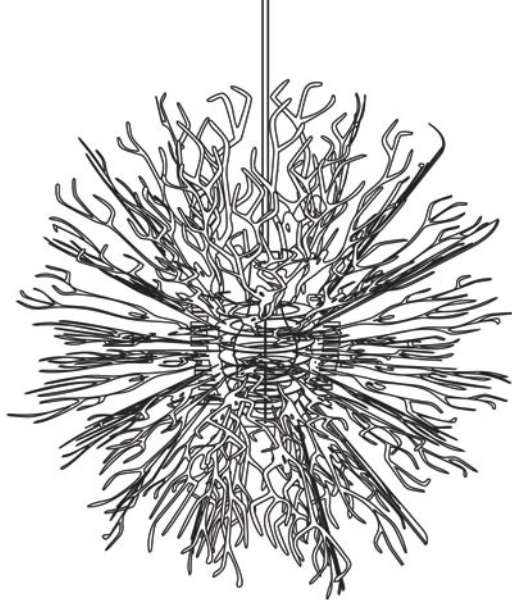

Viable
www.viablelondon.com

flee from the light
charles trevelyan 2006

pendant lampshade in laser cut stainless steel

the multiple fronds of **flee from the light** are designed to scatter the light emanating from the lamp by internal reflection creating a shading effect whilst still allowing shafts of light to emerge. the shade can be entirely assembled by hand, and will be available in two sizes.



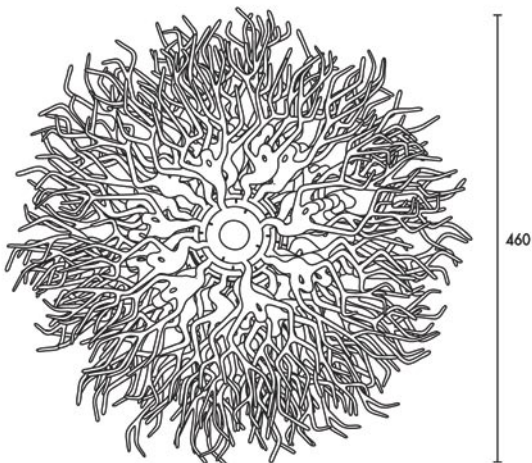

flee from the light

laser cut stainless steel

available in two sizes, 460mm and 380mm

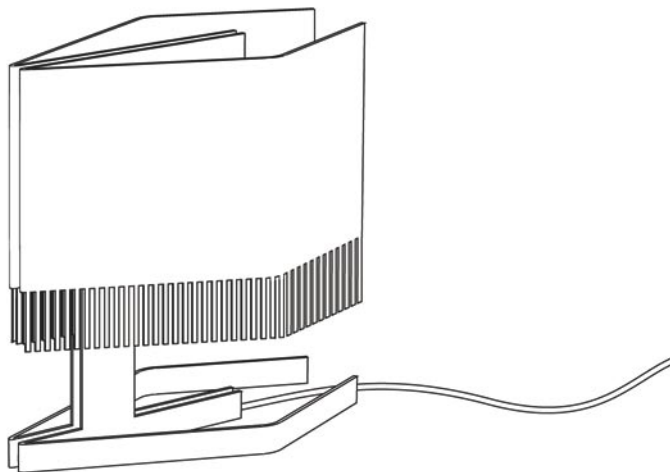

Viable
www.viablelondon.com

harper
charles trevelyan 2006

laser cut steel table lamp with acrylic core

harper is an angular, mechanically styled lamp designed to throw a striking pattern across the surface on which it sits. the opening on one side spills light out in one direction, while the acrylic core gives it a glowing strip down the other.

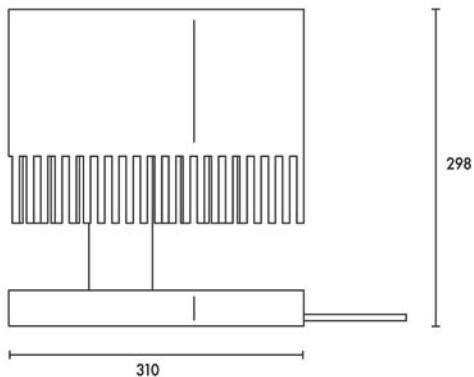
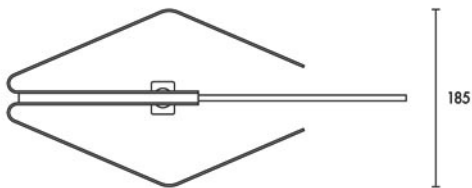

harper

laser cut, powdercoated steel with acrylic core

available in gloss white, signal red and black with clear or yellow acrylic

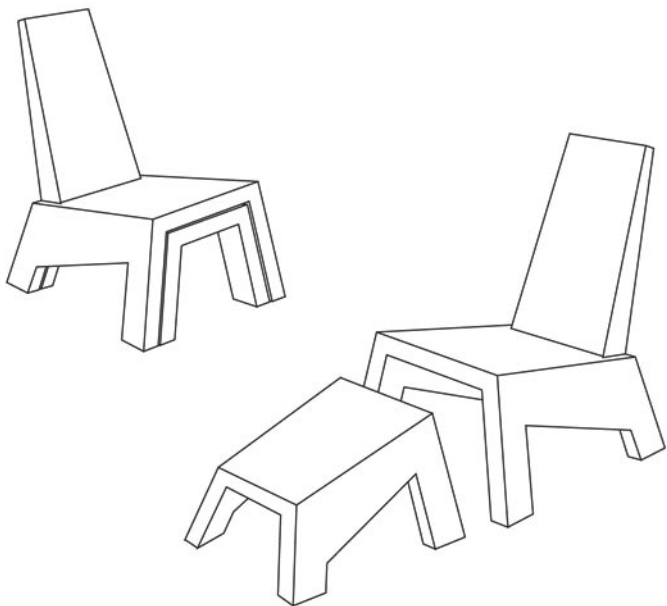

Viable
www.viablelondon.com

helve
charles trevelyan 2006

upholstered nesting chair and footstool

low profile upholstered chair with footstool that stows away under the body of the chair when not in use. carrying over the angular styling that features in several of charles' products, **helve** has a distinctive profile and comfortable slightly reclined position.

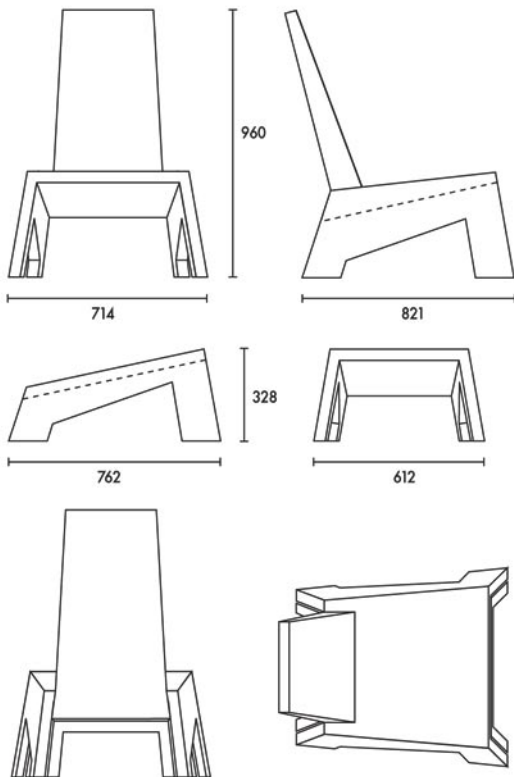

helve

plywood and foam shell upholstered in fabric

available in a range of different fabrics on application

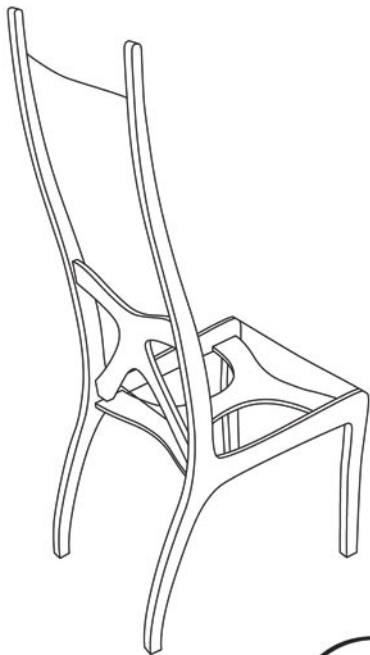

Viable
www.viablelondon.com

high profile chair
magnus long 2006

high-back metal dining chair with mesh seat and back

flat-pack dining chair with high back, laser cut from steel. the mesh seat is interchangeable with other fabric slings, including leather. the **high profile chair** is the first of an intended range of dining, lounge and arm chairs which could be manufactured in various methods

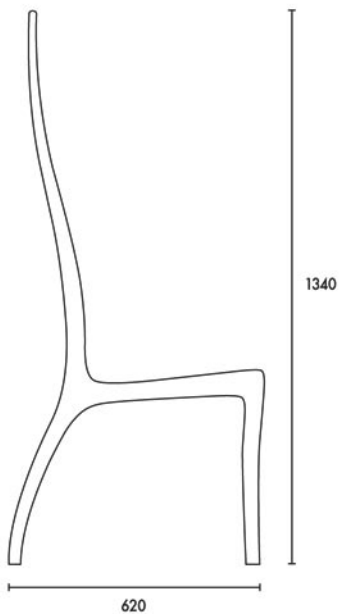

high profile chair

steel and lacquered MDF frame, with mesh seat

available in black with red seam only

mekong

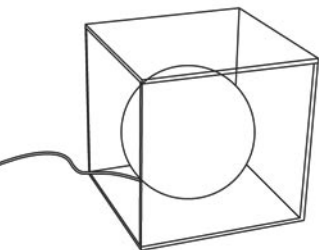
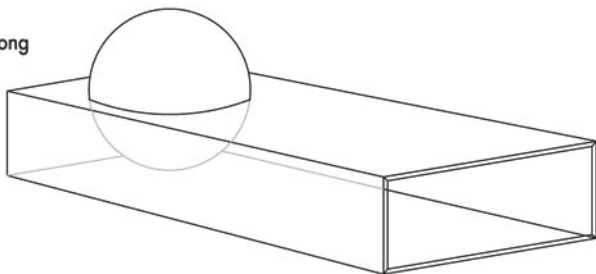

mekong cube

Viable
www.viablelondon.com

mekong
gala wright 2006

range of occasional and coffee tables constructed from two-way mirror glass containing a softly glowing globe.

with the light turned off the tables are fully reflective, yet when illuminated, the light becomes visible with multiple internal reflections. a simple form that produces a stunning visual effect.

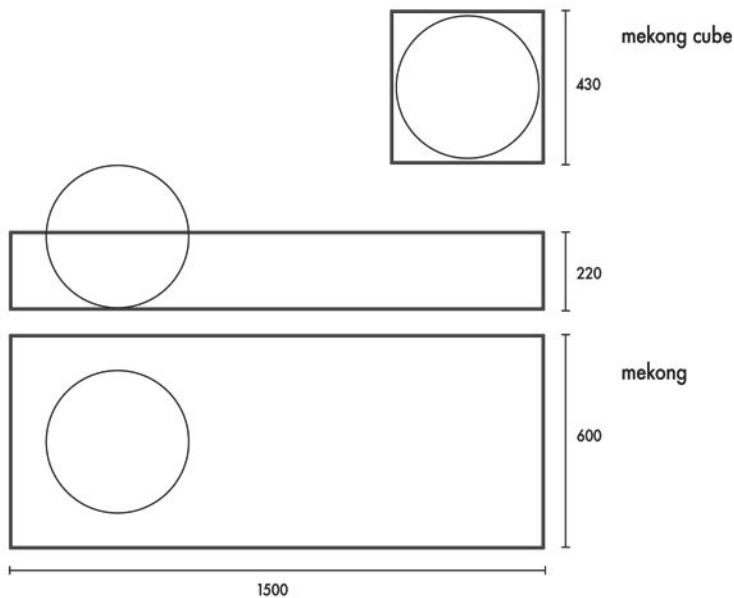

mekong

two-way mirror glass with plastic spherical light

available in sizes shown

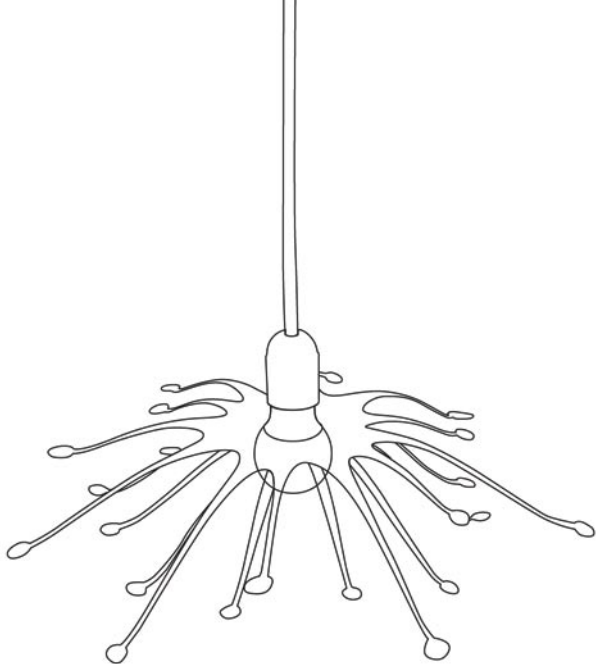

Viable
www.viablelondon.com

petit fleur
magnus long 2006

pendant lampshade in thin steel to fit over waist of a light bulb

delicate pendant lamp shade made from thin laser cut steel. the pendant fits over the waist of a standard bulb or sits above an energy saving bulb. the top of the pendant is either unfinished steel or painted black. the underside is red, which diffuses a warm light

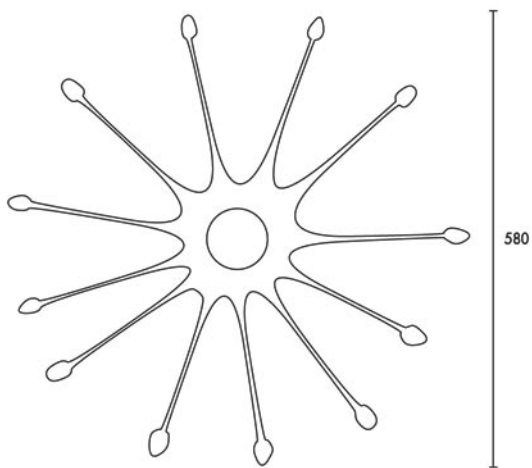

petit fleur

laser cut steel

available in various colour combinations



Viable
www.viablelondon.com

profile table
magnus long 2006

black glass-top table on steel frame

dining table with collapsible, powdercoated steel frame and toughened 19mm glass top. the coated black underside of the glass produces silhouette reflections of what's above. the table is part of the same range as the **high profile chair**.

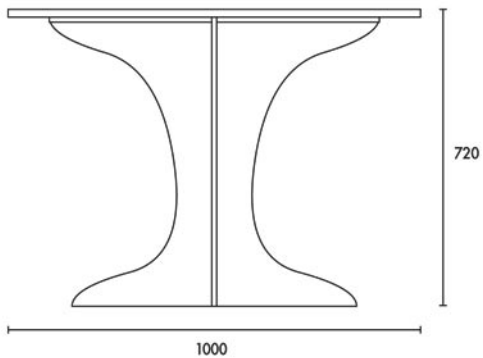

profile table

steel and toughened glass

available in black with red seam only

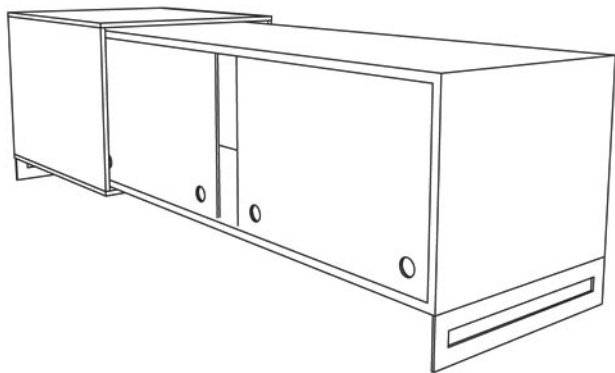

see no evil
gala wright 2006

practical media storage system specifically designed to be used
without revealing the equipment inside.

the use of privacy glass not only allows the audio-visual hardware
within to be concealed, but also reflects the immediate environment
thus giving the storage cabinet an unobtrusive profile.

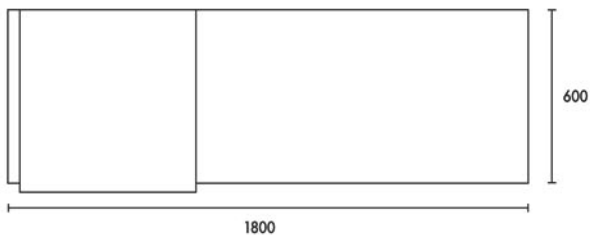
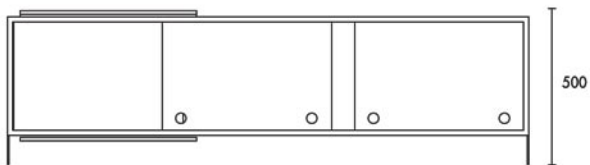

see no evil

coated MDF with two-way mirror glass doors and aluminium fittings

available in aluminium or black nextel suede coating

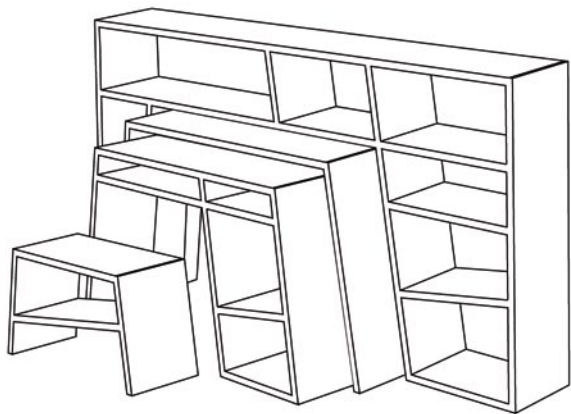

Viabile
www.viablelondon.com

shelflife desk
charles trevelyan 2006

shelving unit that features a retractable two part desk and bench seat.

following on from the highly successful **shelflife** unit, **shelflife desk** replaces the chair and side table of the original unit with a desk space and seating. designed for the apartment without the space for a dedicated desk, **shelflife desk** is both functional and striking.

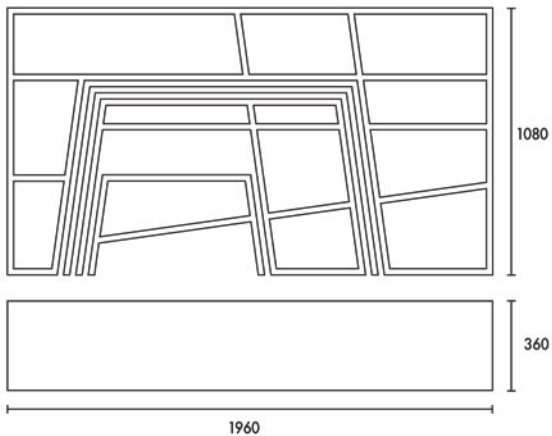

shelflife desk

lacquered LDF (low density MDF)

available in white, eggshell blue and slate grey

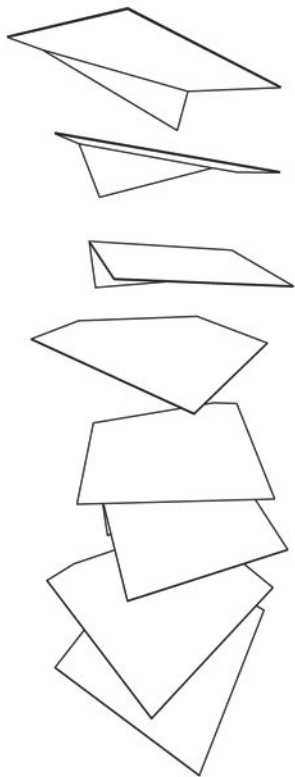

Viable
www.viablelondon.com

shoe shelves
magnus long 2006

angled, powder-coated steel shelves with flexible magnetic heel-supports.

sheet steel shelves for displaying and storing shoes in various configurations. the square shelf is angled towards the viewer to exhibit shoes at their best. flexible magnetic shapes support the heel of the shoe (any type) and prevent them from sliding off. shelves fix directly to the wall individually, or with optional back plate.

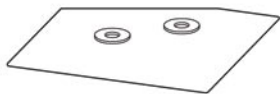
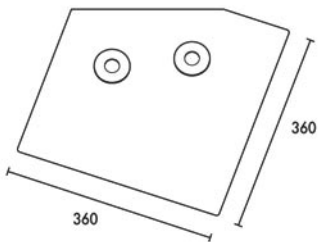

shoe shelves

powdercoated sheet steel with flexible magnet

available in white, red, black and gold

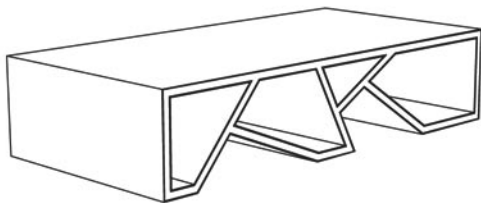

coffee table

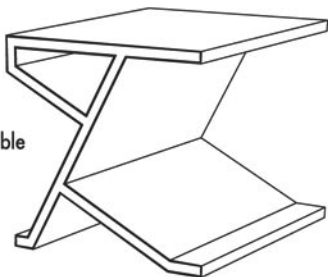

side table



striata
charles trevelyan 2006

range of incidental tables in sheet steel and foam core

the first two in this series, a long low coffee table and a striking x-form side table were debuted in milan in april 2006. the steel skin combines foam core to provide the necessary strength, and gives the pieces a distinctive layered appearance.

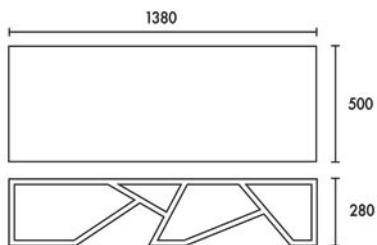

coffee table

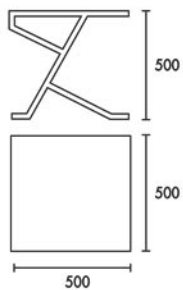

side table

striata

powdercoated mild steel with foam core

available in white, golden yellow, eggshell blue, signal red and black

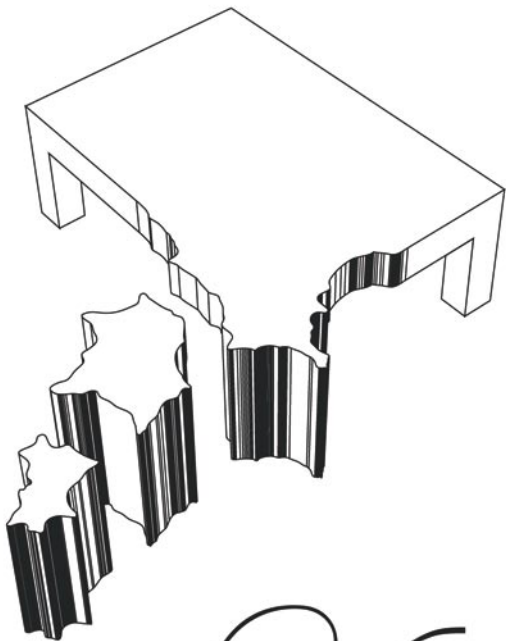

Viable
www.viablelondon.com

archipelago
charles trevelyan 2005

coffee table with accompanying side tables

strongly graphic in its design, **archipelago** extrapolates an irregular 2D form into 3D. the resulting form toys with the idea of furniture as islands within the room, and provides the option of using parts of the cluster as side tables.

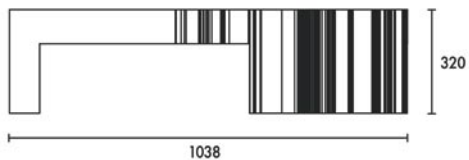
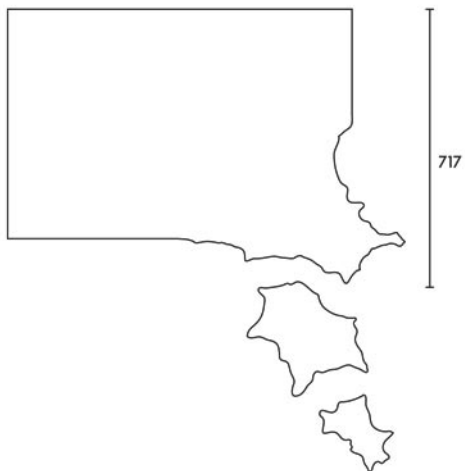

archipelago

lacquered LDF (low density MDF)

available in white, eggshell blue, slate grey and black

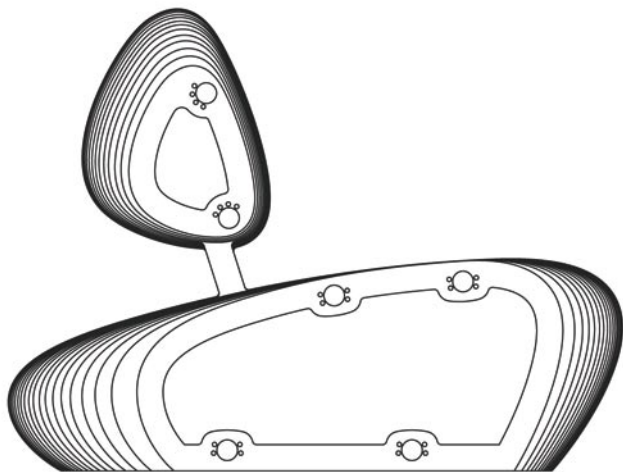

Viable
www.viablelondon.com

baleen
charles trevelyan 2005

indoor/outdoor bench in plywood

originally a commission, **baleen** has been developed into a range of variously sized bench seats. Available as a chair, two seater and three seater bench, **baleen** is built from a series of plywood profiles, finished in a durable lacquer.

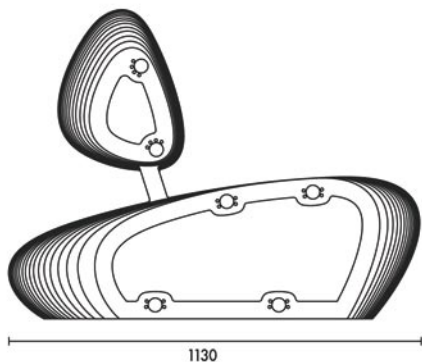

1130

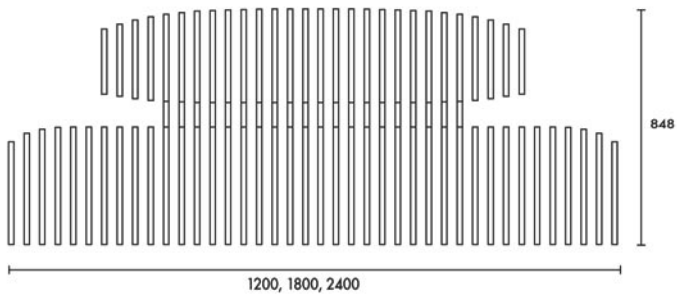

848

1200, 1800, 2400

baleen

lacquered plywood and stainless steel

made to order, colours on application

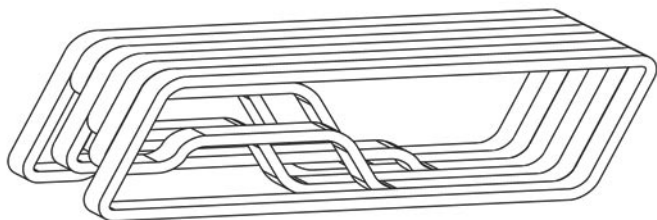

Viable
www.viablelondon.com

harmonic
charles trevelyan 2005

coffee table in laminated plywood

referencing the layering of sound waveforms of different frequencies, **harmonic** is an elegant take on the standard curved ply coffee table. the intersections between each of the "waves" allow objects to be placed in several locations beneath the table.

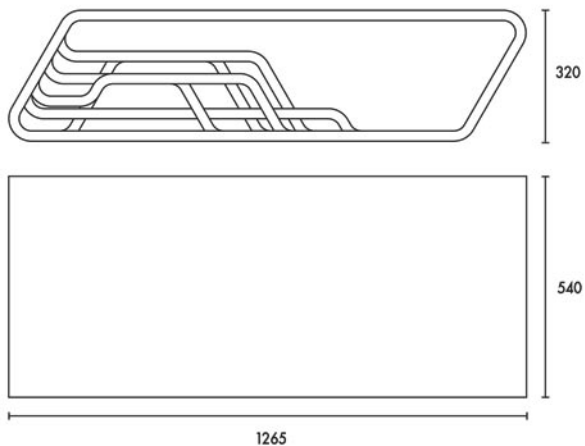

harmonic

laminated plywood finished in clear lacquer

available in natural ply only



Viabile
www.viablelondon.com

hide n peek
gala wright 2005

double bed with aluminium ball chain canopy.

a minimal stainless steel frame of the bed is clad with aluminium ball chain curtains on all sides, creating an alluring, shimmering cube from the outside and an intimate cocooned space on the inside.

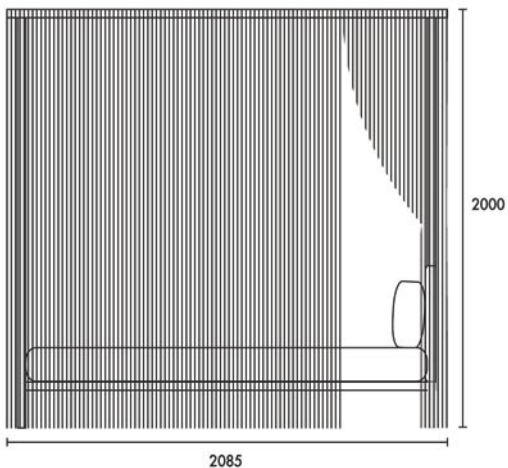

hide n peek

steel frame, aluminium ball chain, upholstered headboard

made to order - special finish and alternative ball chain materials available

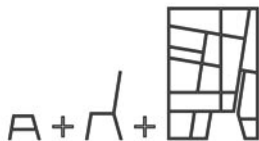
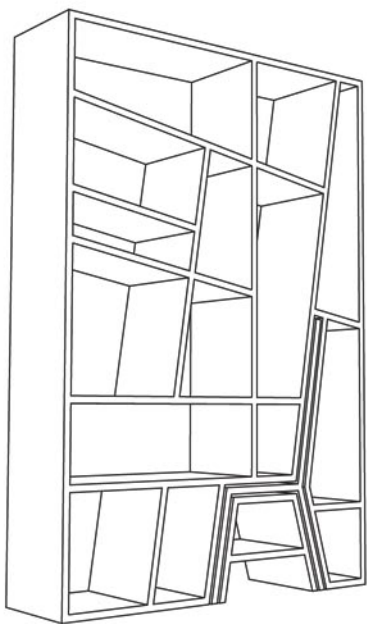

Viabile
www.viablelondon.com

shelflife
charles trevelyan 2005

shelving unit or room divider with removable chair and side table

shelflife's striking angular appearance belies a practical functionality. angular shelves prevent books from toppling, while the chair and table provide a convenient place to browse the collection

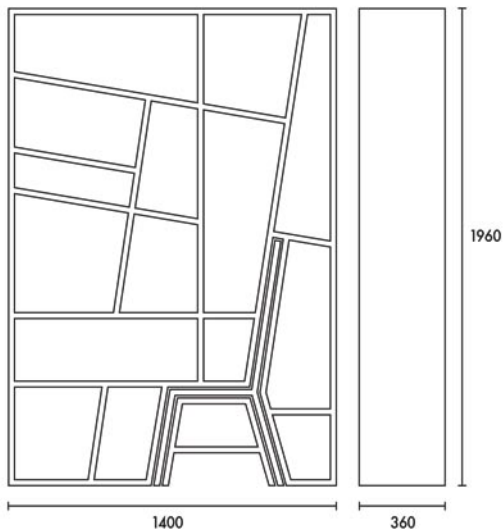

shelflife

lacquered LDF (low density MDF)

available in white, eggshell blue and slate grey

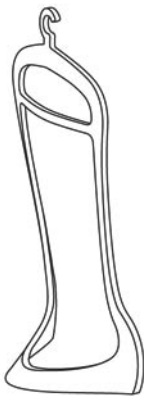
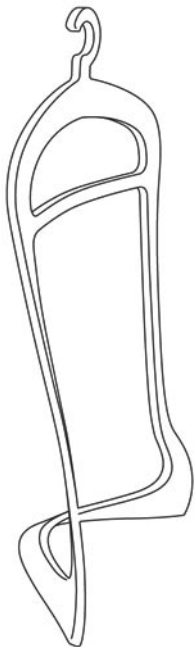

Viable
www.viablelondon.com

standing hanger
magnus long 2005

freestanding clothes frame for displaying, hanging
and drying clothes.

the standing hanger can be used as a stand-alone
clothes valet or hung from a rail using its hook. the
shape of the foot allows the clothes frames to fit
snugly together in a line.

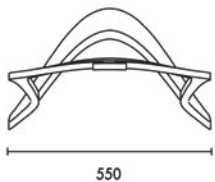
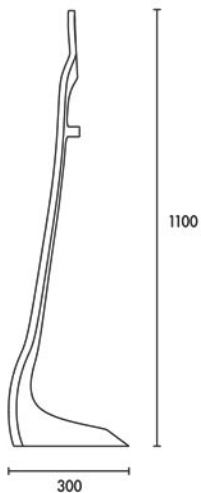
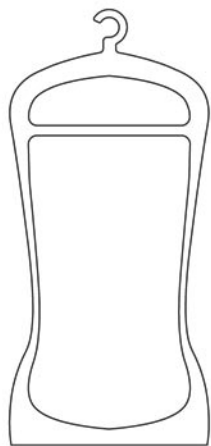

standing hanger

fibreglass

available in red, black, white and british racing green

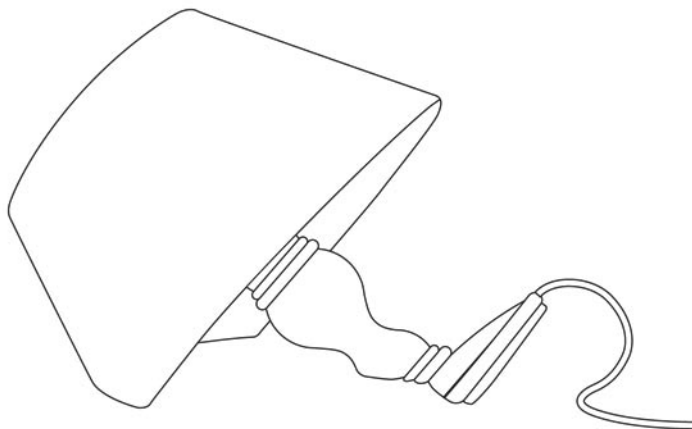

Viable
www.viablelondon.com

titanic
charles trevelyan 2005

table lamp

leaning as if sinking below the surface of the table, titanic is designed to throw a wash of light across a room.

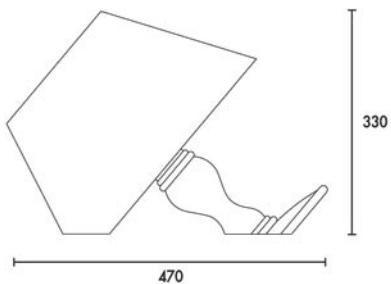

titanic

lacquered wooden base with cotton and steel shade

available in white only, US and European configurations on request